

Digital

(High Reliable intelligent Quad Series)

Quad-Beam Active Infrared Sensor

- LK-60HQ (Outdoor 60m)
- LK-110HQ (Outdoor 110m)
- LK-160HQ (Outdoor 160m)
- LK-200HQ (Outdoor 200m)
- LK-250HQ (Outdoor 250m)

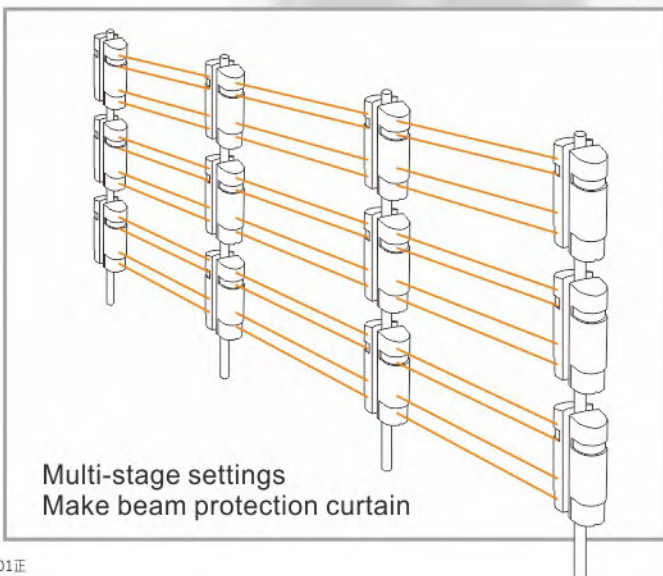

LED level meter for beam alignment. Three LEDs on the receiver act as a level meter to visually display the beam reception level. 10-level LED indicator enables quick and accurate beam alignment.

Features

1. Quad Beam detection.
Four synchronized pulsed infrared beams ensure ultimate stability in any applications.
False alarms due to falling leaves and small animals are virtually eliminated
2. Easy optical alignment with LED indication
 - ⊙ 10-level LED indicator, we can check beam strength easily.
 - ⊙ Highly accurate alignment, no need to use voltmeter.
 - ⊙ No need for using beam blocking plate.
3. Selectable 8-channel beam frequencies.
Selectable beam frequencies for beam stacking and long distance applications without crosstalk.

Beam stacking applications

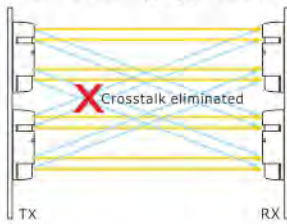

Long distance applications

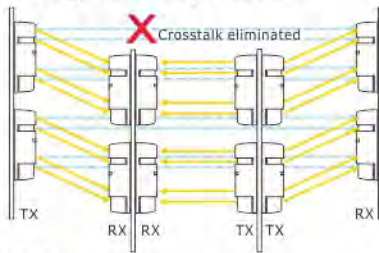

4. Up to 8-sets for multiple installation.
5. Adjustable beam interruption period (50-700msec)
6. Lighting & Surge protection. Automatic gain control circuit.
7. Form C relay providing more applications.
8. Anti-Frost design.
9. Target, structure color is tuned to the peak wavelengths of human vision, to be easily targeted in the beam alignment process.



Terminals

Transmitter

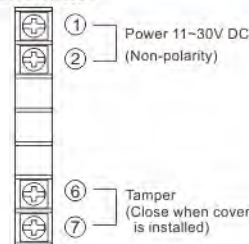

Receiver

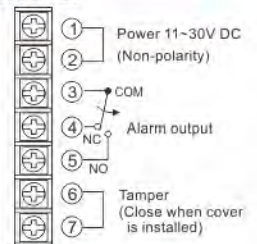

Dimensions

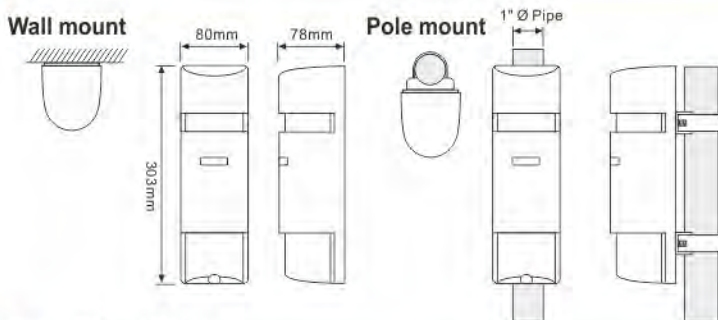

Detection Range

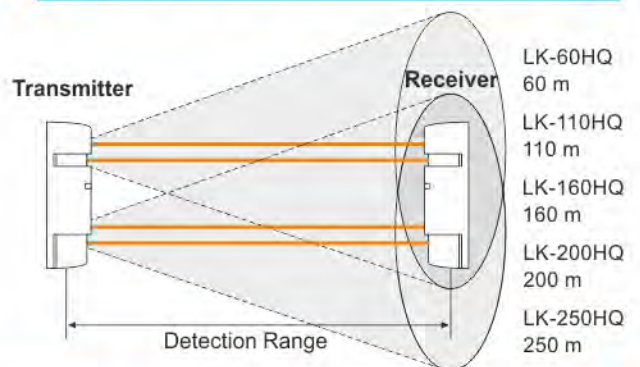

Specification

Model	LK-60HQ	LK-110HQ	LK-160HQ	LK-200HQ	LK-250HQ
Coverage outdoor use	60 m	110 m	160 m	200 m	250 m
Infrared beam	4-Beams(4 beams simultaneous interruption alarm activated)				
Selectable beam frequency	CH1 ~ CH8 8 channels				
Response time	50~700msec (variable)				
Power input	11~30VDC (no polarity)				
Power consumption (at 12VDC input)	70 mA	80 mA	90 mA	100 mA	120 mA
Indication LED	Power LED: RED LED (transmitter) / ALARM LED: RED LED (receiver) BEAM alignment level LED: 3 RED LEDS (receiver)				
Alarm duration	1 ±0.5sec				
Relay output	Form C relay dry contact, 1A/120VAC,2A/24VDC (resistor load)				
Tamper	open when cover is removed (1A/120VAC)				
Alignment angle	Vertical 20° (±10°), horizontal 180° (±90°)				
IP rating	IP55				
Mounting	Wall mount or pole mount				
Operation temperature	-25°C ~ +60°C				
Weight	1310g				
Accessories	Wall mount screw (8 pcs), pole mount screw (8 pcs), metal mounting bracket (2 pcs), mounting hook (4 pcs), U-clamp (4 pcs)				